

Eco Preparation 1200 mm Wall Cupboard with 2 Sliding Doors

ITEM # _____

MODEL # _____

NAME # _____

SIS # _____

AIA # _____

132922 (SPS12LCN)

Wall Cupboard with 2 sliding doors, 1200mm

Short Form Specification

Item No. _____

Constructed in stainless steel. Inner door, intermediate shelf, rear panel and reinforcements in stainless steel. Double-walled sliding doors. Handles are formed by a fold in the sliding doors. Back and bottom are made from a single bended stainless steel

Main Features

- Sturdiness, stability and reliability of table accurately tested.

Construction

- Wall cupboard features an ergonomic handle and an internal shelf which can be positioned at three different levels.
- Two double-walled sliding doors flush fitting to the front of the frame can easily be removed without the use of tools to facilitate cleaning of the cupboard interior.
- Constructed entirely in stainless steel to offer maximum durability.
- Sturdy sound-deadened sliding doors on tracks located flush to the front of the frame.
- Scotch Brite finish to meet the highest hygiene standards.

Optional Accessories

- Lighting kit with led for wall cupboards (1000mm and 1200mm) PNC 850709
- Lighting kit with led for wall cupboards (1400mm, 1600mm and 1800mm) PNC 850710

APPROVAL: _____

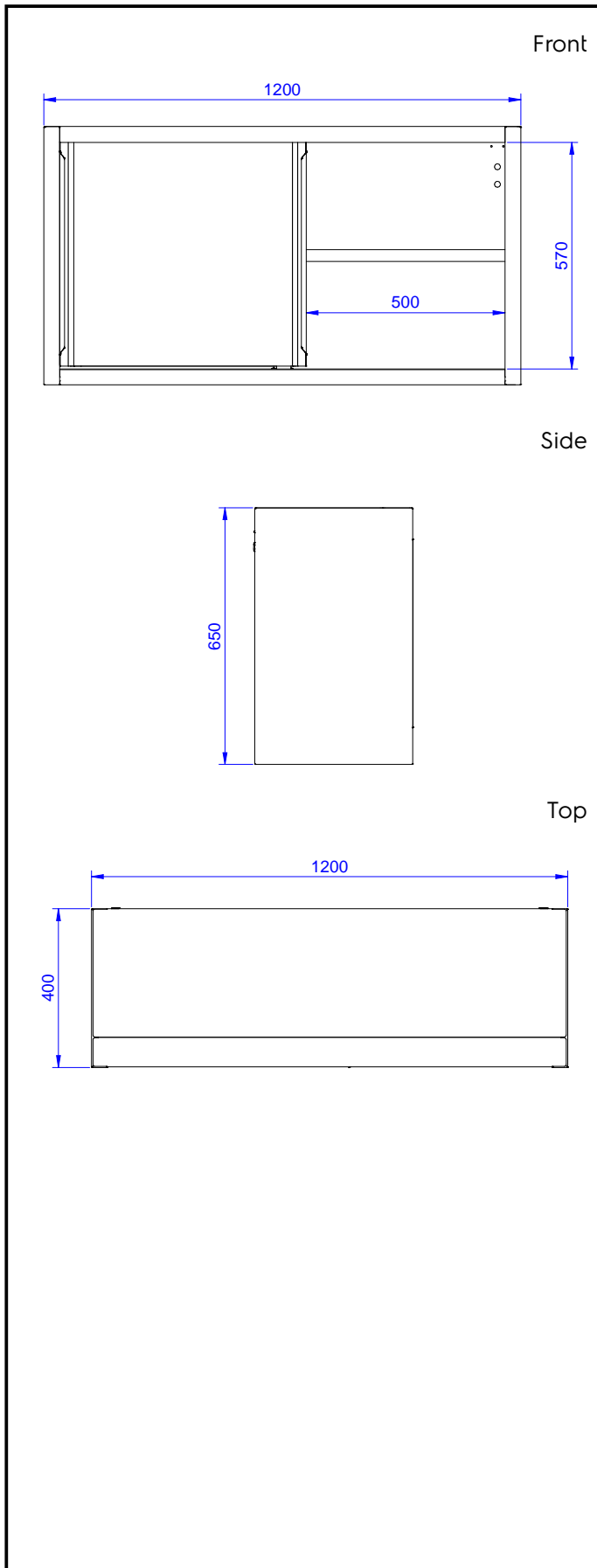

Key Information:

N° of doors:	2
132922 (SPS12LCN)	
External dimensions, Width:	1200 mm
External dimensions, Depth:	400 mm
External dimensions, Height:	650 mm